

C.CRANE

CCWiFi

Internet Radio



INSTRUCTION MANUAL

Rev. 12



Before Use



Please read **IMPORTANT SAFETY**

INSTRUCTIONS on page 43 before use. It is important to read and understand all instructions. Keep these precautions and instructions where all who use this radio will read them.

WARNING: TO PREVENT FIRE OR ELECTRIC SHOCK HAZARD, DO NOT EXPOSE THIS PRODUCT TO RAIN OR MOISTURE.

CAUTION

**RISK OF ELECTRIC SHOCK
DO NOT OPEN**

CAUTION: TO REDUCE THE RISK OF ELECTRIC SHOCK, DO NOT REMOVE THE RADIO BACK. NO USER SERVICEABLE PARTS INSIDE. REFER SERVICING TO QUALIFIED SERVICE PERSONNEL.



THE LIGHTNING FLASH AND ARROWHEAD WITHIN THE TRIANGLE IS A WARNING SIGN ALERTING YOU OF "DANGEROUS VOLTAGE" INSIDE THE RADIO.



THE EXCLAMATION POINT WITHIN THE TRIANGLE IS A WARNING SIGN ALERTING YOU OF IMPORTANT INSTRUCTIONS ACCOMPANYING THIS RADIO.

CAUTION

- Slowly increase the sound until you can hear it comfortably and clearly without distortion.
- Long-term exposure to loud sounds may cause hearing damage. It is best to avoid high volume levels when using headphones/ earbuds, especially for extended periods.

For your future reference:

Serial No. _____ Date of Purchase _____
Name & Address of Dealer _____

Unpacking

The box should contain the CC WiFi Radio, AC adapter, and this manual. If anything is missing or damaged, please contact your dealer immediately. We recommend you keep the box in the unlikely event your radio needs to be serviced.

Copyright © 2008-2017
C. Crane Company
172 Main St, Fortuna, CA 95540-1816
Phone: 1-800-522-8863 Web: ccrane.com

All rights reserved. No part of this booklet may be reproduced, in any form or means whatsoever, without permission in writing from C. Crane Company, Inc.

Table of Contents

Unpacking	2
Location of Controls	4-5
Getting Started	
Turning the Radio On	6
Connecting to a Wireless Network	7
Entering Your WEP or WPA Key	8
Choosing a Radio Station	11
Searching for a Station	13
Searching for an iHeart Station.....	14
Searching for a CBS Radio Station.....	15
Changing the Volume	17
Storing a Station as a Preset	17
Play a Stored Radio Station Preset	17
Menu Time Out	18
Setting the Time and Date	18
Setting the Alarm	19
Setting the Sleep Timer	21
Media Player Functions	22
Configure Menu Options	26
Configuring “My Stuff”	28
Configuring “My Stations”	28
Adding Content to “My Streams” or “My Podcasts”	29
Setting Up Extra Features	30
Using “My Pandora”	30
Help Pages	33
Menu Flow Charts	40
Safety Instructions	43
Memory Preset Log	44
Location of CC WiFi Radio Serial Number	48
Software License Information	48

Thank you for choosing the CC WiFi radio. Read this manual carefully to get the best performance from this unit.

Location of Controls – Front and Back of Radio

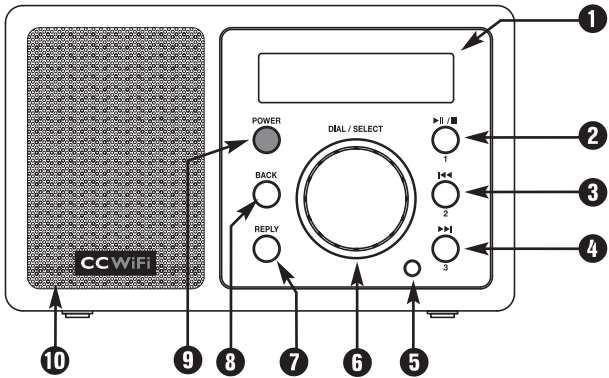

- 1** LCD Display
- 2** PLAY/PAUSE/STOP or PRESET #1
- 3** PREVIOUS or PRESET #2
- 4** NEXT or PRESET #3
- 5** Remote Sensor
- 6** DIAL/VOLUME/SELECT
- 7** REPLY
- 8** BACK
- 9** POWER ON/OFF
- 10** Speaker

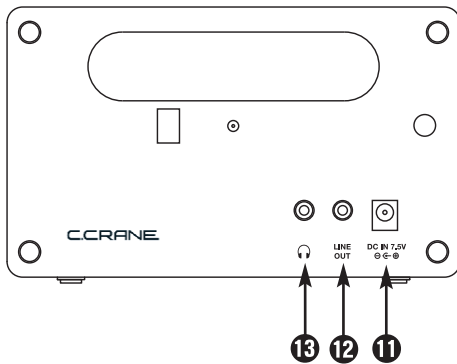

- 11** DC Power Jack
- 12** Line Out Jack
- 13** Headphone Jack

Location of Controls – Remote Control

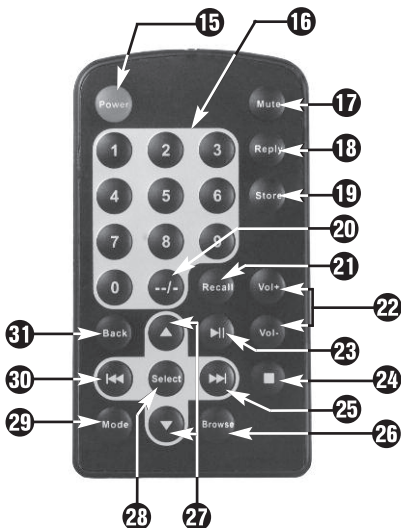

Buttons 23-26 and 29-30 are used only in Media Player mode while playing tracks from your computer.

- | | |
|--|---|
| 15 POWER: Switch radio ON/OFF | 24 STOP: Stop track play. Press and hold to delete a track from the playlist |
| 16 0-9: Store presets and recall functions | 25 NEXT: Play next track |
| 17 MUTE: Mute the audio | 26 BROWSE: View tracks in playlist |
| 18 REPLY: Used for Pandora, and adding stations to Reciva | 27 UP/DOWN: Scroll through options |
| 19 STORE: Store up to 99 radio stations | 28 SELECT: Select a displayed option |
| 20 --/--: Used for presets 11 and above | 29 MODE: Switch between Repeat and Shuffle modes |
| 21 RECALL: Play pre-set stations | 30 PREV: Play previous track |
| 22 + or - VOL: Adjust volume | 31 BACK: Reverts back to the previous menu or option |
| 23 PLAY/PAUSE: Play or pause track | |

Getting Started – Turning On Your WiFi Radio

Plug the power adapter cube into a 120V AC power outlet. Connect the power adapters small plug into the jack on the back of the radio that is labeled “DC IN 7.5V”.

Caution: Use only the power adapter supplied with the radio. Connecting a power adapter other than the one that was supplied with your radio could cause permanent damage to the radio and may be hazardous.

After a few seconds the display on the front of the radio will light up and show:

CC WiFi Radio

Followed by:

Reciva Enabled
ARM Powered

Followed by:

Starting ...

and

Initializing
Network

Followed by:

Scanning

If the radio cannot find any wireless networks, then the display will show:

No networks
found

If no networks are found, see page 33 for troubleshooting assistance.

Getting Started – Turning On Your WiFi Radio

Connecting to a Wireless Network

When the radio finds wireless networks, it will show the network names (also called the ESSID) in the display screen.

Example:



Note: You can always use the BACK button to start over at the previous screen.

The wireless network will show in the display after the wireless network scan. There may be more wireless networks to choose from by further rotating the dial.

Example:

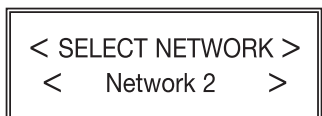

To connect to your wireless network, select it by pushing the dial in.

Need Help?: Refer to help page 33 for help finding which SSID (Network Name) is yours.

Connecting to a Wireless Network

If the display shows:



then continue on to page 11.

However, if the screen displays:

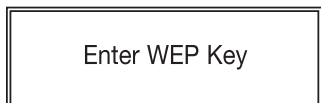

or

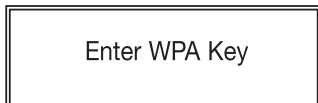

you must enter the correct WEP or WPA wireless encryption key (Wireless Password) to proceed.

Note: Take note which type of key your network requires for future reference.

Entering Your WEP or WPA Key (Wireless Password)

Need Help?: Refer to help page 33 for help finding your WEP or WPA Key.

After a few seconds the display will go into a password entry mode. This mode contains upper case letters, lower case letters, numbers, and special characters.



Notice that the letter “A” is separated from the other characters in the center of the display. Rotate the dial and you will see how the center character is always separated from the other characters. Continue rotating the dial until the first character of your WEP or WPA password is in the center of the display. Select it by pressing the main dial in.



After you have selected the first character of your password, it will appear below.

Entering Your WEP or WPA Key (Wireless Password)

ABCDE F GHIJ
F _

Turn the dial to the next character in the password - press the dial to select.

Repeat this process until your entire wireless password is entered on the lower line.

Example:

XYZab c defg
Frank12abc _

Note: WEP passwords use numbers 0-9 and upper case letters A-F. WPA passwords are case sensitive to upper and lower case letters, so you must enter them exactly.

After the final character is entered, turn the dial until “END” shows in the middle of the display — press the dial to select.

()“ END ◀▶ A

The display will show “Connecting to network” as the radio connects to the WiFi network.

Connecting to
Network

and

Connecting to
“My Network”

Your network’s name will be displayed here.

Then:

Station Update
From Reciva

Need Help?: Refer to help pages 33-37 for troubleshooting connection problems.

When finished, the radio automatically goes to the “Primary Menu” that contains six options: **STATIONS, PERSONAL RADIO, MY STUFF, MEDIA PLAYER, CONFIGURE and ALARM CLOCK.**

Entering Your WEP or WPA Key (Wireless Password)



Note: Menu tree flow charts are located on pages 40-42. To begin choosing stations skip to “Choosing a Radio Station” on page 11.

Choosing a Radio Station

1. From the Primary Menu, choose “Stations” by turning the dial until brackets are positioned on both sides. Press the dial to select.

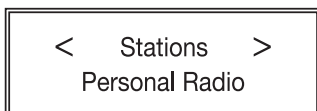

2. Next, turn the dial to choose a radio station from either the “**Location**”, “**Genre**” or “**Search**” menu. Press the dial to continue into the selected menu.

Note: The “Location” menu lets you choose a radio station from a particular continent then country. The “Genre” menu lets you choose a radio station by categorized content – for example: “Dance, Classical, Rock, Talk” etc. For direct station name entry, see “Searching for a Station” on page 13.

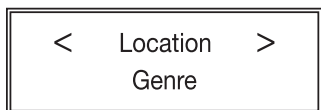

or

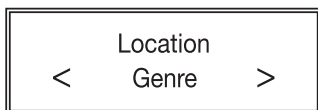

Need Help?: To find which genre or location contains your favorite station, refer to help page 37.

3. After pressing “**SELECT**” on “**Location**” or “**Genre**”, rotate the dial to scroll through the locations or genres. Selections are listed in alphabetical order.

Press the dial to continue into the selected menu.

By Location:



or

By Genre:



4. After loading, the first two radio stations will show in the display screen.

Choosing a Radio Station

Example:

< 101 RU Classic >
101 RU Humor

Radio stations are listed in alphabetic order, so you may need to turn the dial many times until your desired station is reached.

5. Press the dial to listen to a selected station.

Example:

< KGO-AM 810 >
KGUM 570 AM

The display will show “Connecting” followed by “Buffering”. The connecting process can sometimes take up to a minute or two, depending on the speed of the station.

Example:

< KGO-AM 810 >
Connecting /

followed by

< KGO-AM 810 >
Buffering 50%

Once the station is fully buffered, it will begin to play. You may need to turn up the volume by using the same dial.

When a station is playing, the following information will show on the display (for example):

Station Name:	BBC Radio 1
Audio quality, and Audio format:	32 kbps WMA
Player that the radio is using:	Real Enabled

Searching for a Station

You can search for an Internet radio station by directly entering the station name or call letters into the radio.

1. From the Primary Menu, choose “**Stations**” by turning the dial until brackets are positioned on both sides. Press the dial to select.

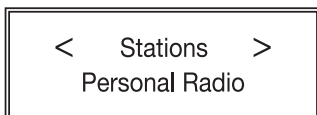

2. Next, turn the dial clockwise past “**Location**” and “**Genre**” to “**Search**”. Press the dial to select.

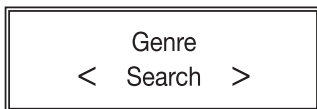

3. Rotate the dial clockwise until the first character of the desired station name is displayed in the top/middle and press the dial to select. The selected character will show beneath the other characters on a separate line. Continue on to the next character in the desired station name until all characters are entered.

The example below shows KGO entered into the search feature.



4. When finished, rotate the dial until “**END**” is located in the top/middle of screen and then press the dial to select.

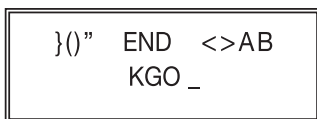

5. The radio will now display the station names resulting from the search. You can rotate the dial to browse through the results. When you are ready to play a station align the brackets on either side of the station name and press the dial to select.



Searching for an iHeart Station

You can search for an iHeartRadio station by selecting “**iHeartRadio**” listed in the stations menu.

1. From the Primary menu, choose “**Stations**” by turning the dial until brackets are positioned on both sides. Press the dial to select.



2. Next, turn the dial clockwise past “**Location**”, “**Genre**”, “**Search**” until the brackets are positioned on both sides of “**iHeartRadio**”. Press the dial to select.



3. There are four choices to find iHeartRadio stations:

Search
Local
Genre
Location

The “**Search**” option allows you to enter the station name or call letters into the radio. See page 13-#3 to use the “**Search**” option.

The “**Local**” option shows stations based on your location.

The “**Genre**” option lets you choose a radio station by categorized content - for example: “**Classic Rock, Jazz, News and Talk, Public Radio**”, etc.

The “**Location**” menu lets you choose a radio station by State and then by City.

Searching for an iHeart Station

4. After selecting “**Browse by Genre**” or “**Browse by Location**”, rotate the dial to continue into the selected menu.
5. Rotate the dial to locate the desired station. You may need to turn the dial many times until your desired station is reached.
6. Press the dial to listen to the selected station. (Example):



Searching for a CBS Radio Station

1. From the Primary Menu, choose “**Stations**” by turning the dial until brackets are positioned on both sides.

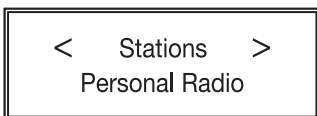

2. Next, turn the dial clockwise past “**Location**”, “**Genre**”, “**Search**” and “**iHeartRadio**” until the brackets are positioned on both sides of “**radio.com**.” Press the dial to select.



3. There are three choices to find radio.com stations:

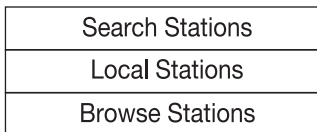

Searching for a CBS Radio Station

The “**Search Stations**” option allows you to enter the station name or call letters into the radio. See page 13-#3 to use the “Search” option.

The “**Local Stations**” option shows stations based on your location.

Browse Stations

There are three choices to find radio.com stations:

All Stations
By Location
By Genre

4. The “**All Stations**” option shows all of the radio com stations listed in alphabetical order. After selecting “**All Stations**” rotate the dial to scroll through the stations. Press the dial to select your desired station.
5. The “**By Location**” option lets you choose a radio station by State. Once you select the desired State, you can then select “**All Stations**” or “**By Genre**”. Rotate the dial to locate the desired station. You may need to turn the dial many times until your desired station is reached.

Arizona
< California >

All Stations
Genre

6. The “**By Genre**” option lets you choose a radio station by categorized content - for example: “60s, 70s, Classic Rock, Jazz, News, Talk, Oldies” etc. Once the desired Genre is selected, select “**All Stations**” or “**Americas**” (to search by State).

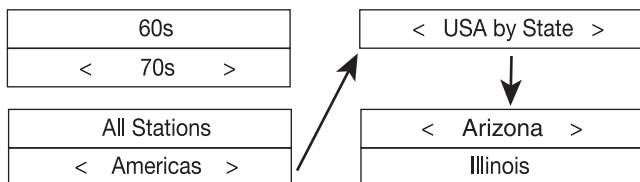

Changing the Volume

You can change the volume by turning the dial clockwise to increase the volume and counterclockwise to decrease the volume. The display shows the volume bar. You cannot change the volume when you are in a menu, except when using the remote control. After a station is selected and begins to play, you can then change the volume with the main dial.

Store a Radio Station as a Preset

- A. Using the Controls on the Front of the Radio to Store Presets 1-3:
While a radio station is playing, press and hold one of the preset buttons for three seconds or until the display screen shows “Assigned to Preset”.
- B. Using the Remote Control to Store Presets 0-9 (0=10):
While a radio station is playing, press and hold the preset number on the remote control that you want the station to be stored to. After three seconds the display screen will show “Assigned to Preset”.
- C. Using the Remote Control to Store Presets 11-99:
While a radio station is playing, press the STORE button, then the -/-- button, and then enter your desired preset number. The display screen will show “Assigned to Preset”.

Play a Stored Radio Station Preset

- A. Using the Controls on the Front of the Radio to Play Presets 1-3:
Briefly press and release the preset button assigned to the station you want.
- B. Using the Remote Control to Recall Presets 0-9 (0=10):
Briefly press and release the preset button assigned to the station you want.
- C. Using the Remote Control to Recall Presets 11-99:
Briefly press the RECALL button, then the --/- button, and then enter your desired preset number 11-99.

Menu Time-Out

When a radio station is playing — if BACK or SELECT is pressed, the radio will go into menu selection mode. If no radio controls are used within ten seconds, the radio will “time-out” and go back to the currently playing radio station.

Setting the Time and Date

Note: At any point, you can use the BACK button to start over at the previous screen.

1. If you are currently listening to a radio station, briefly press the dial once to access the Primary Menu. You can also access the Primary Menu by pressing and holding the BACK button.

The Primary Menu contains six options: **STATIONS, PERSONAL RADIO, MY STUFF, MEDIA PLAYER, CONFIGURE** and **ALARM CLOCK**.

2. Turn the main dial until “**Configure**” shows in brackets — press the dial to select.



3. Turn the dial clockwise to “**Clock Setup**” — press the dial to select.



4. Turn the dial to “**Set Time/Date**” — press the dial to select..

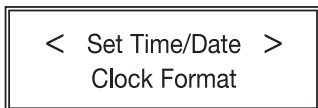

5. Turn the dial until the hour setting is correct — press the dial to select.
6. Turn the dial until the minute setting is correct — press the dial to select.

Setting the Time and Date

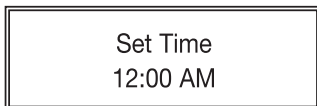

7. Turn the dial until the day of the month is correct — press the dial to select. Follow the same method for setting the month and year.

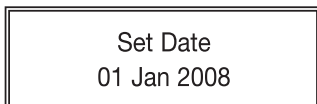

8. When finished, the radio will show “Time and Date Set”.

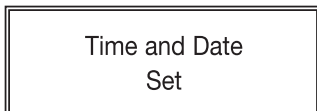

Setting the Alarm

Note: At any point, you can use the BACK button to start over at the previous screen.

1. If you are currently listening to a radio station, briefly press the dial once to access the Primary Menu. You can also access the Primary Menu by pressing and holding the BACK button.
The Primary Menu contains six options: **STATIONS**, **PERSONAL RADIO**, **MY STUFF**, **MEDIA PLAYER**, **CONFIGURE** and **ALARM CLOCK**.
2. Turn the main dial clockwise until “**Alarm Clock**” shows in brackets — press the dial to select.

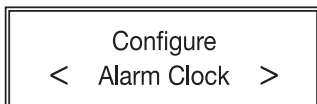

3. Turn the dial until “**Set Alarms**” shows in brackets — press the dial to select.

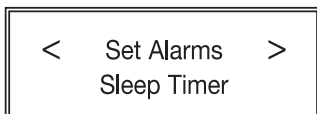

Setting the Alarm

4. Turn the dial and choose one of the five alarm slots to set — press the dial to select.



5. Turn the dial and select “Modify Alarm”

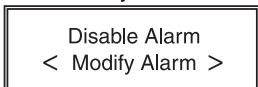

6. Turn the dial until the hour setting is correct — press the dial to select.
7. Turn the dial until the minute setting is correct — press the dial to select.



8. Choose how frequently you want the alarm to sound. Choose between “**Once**”, “**Every Day**”, “**Weekly**”, “**Week Days**”, and “**Weekends**” — press the dial to select.

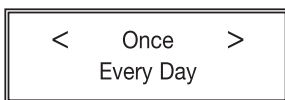

Note: If “**Once**” or “**Weekly**” is selected, you will also be prompted to select the day of the week that you would like the alarm to sound.

9. Choose whether to sound the alarm as a buzzer, play current station, or a preset station — press the dial to select.



Note: If you do not have any station currently playing or any stations stored as presets, then “**Buzzer**” will be your only option

10. Rotate the dial to choose the Alarm Volume from 0-28.
— Press the dial to select.

When the setup is finished, the display will show “**Alarm Set**”.



Setting the Sleep Timer

With the sleep timer enabled, the internet radio will automatically switch itself off after a set amount of time.

Note: At any point, you can use the BACK button to start over at the previous screen.

1. If you are currently listening to a radio station, briefly press the dial once to access the Primary Menu. You can also access the Primary Menu by pressing and holding the BACK button.

The Primary Menu contains six options: **STATIONS**, **PERSONAL RADIO**, **MY STUFF**, **MEDIA PLAYER**, **CONFIGURE** and **ALARM CLOCK**.

2. Turn the main dial clockwise until **“Alarm Clock”** shows in brackets — press the dial to select.

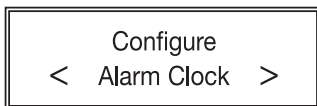

3. Turn the dial until **“Sleep Timer”** shows in brackets — press the dial to select.

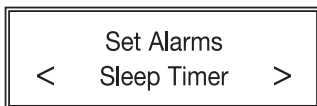

4. The radio will show **“Sleep Timeout”** and the amount of time before the radio turns off. By default the sleep timer is turned off.



5. Turn the dial to increase the amount of time before the radio turns itself off. 15 minute increments are used. Press the dial to select.

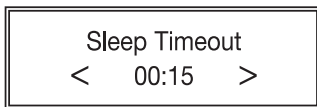

Media Player Functions

6. “Timer Set” will show in the display indicating that the radio will play for the selected amount of time before switching itself off.

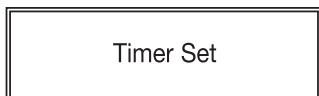

Media Player Functions

The CC WiFi Radio is able to play the following audio formats:

<u>FILE TYPE</u>	<u>FILE EXTENSION SHOWN ON PC</u>
MP3	.mp3
Windows Media	.wma
Real	.ra
iTunes	.aac
Ogg Vorbis	.ogg

Accessing a Computers Stored Audio

Note: At any point, you can use the BACK button to start over at the previous screen.

1. If you are currently listening to a radio station, briefly press the dial once to access the Primary Menu. You can also access the Primary Menu by pressing and holding the BACK button.

The Primary Menu contains six options: **STATIONS, PERSONAL RADIO, MY STUFF, MEDIA PLAYER, CONFIGURE** and **ALARM CLOCK**.

2. Turn the main dial clockwise until “**Media Player**” shows in brackets — press the dial to select.



and
then

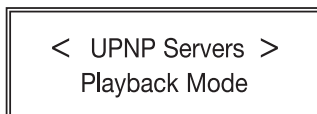

Media Player Functions

Using “UPNP Servers” to access stored audio:

This method scans for Universal Plug and Play (UPNP) servers on the network. UPNP servers gather media and distribute to other network devices.

If using a Mac: You will be required to use third party software to enable your computer as a UPNP server.

If using Microsoft Windows XP through Windows 10: It is possible to use your computer as a UPNP server without installing additional software. Depending on your version of Windows, enabling the UPNP server is different. It is best to consult the web for instructions on how to enable the UPNP Server on your particular Windows OS version.

1. On your CC Wifi, press the dial and select “**UPNP Servers**”.
2. Choose your desired UPNP server.

Note: You can use the media controls on radio or the media controls on the remote control to access audio.

1. Turn the dial to “**Music**” — press the dial to select.
2. Turn the dial to “**Album Artist**” — press the dial to select.
3. Turn the dial to the desired artist — press the dial to select.
4. Turn the dial to the desired album — press the dial to select.
5. Turn the dial to the desired audio track — press the dial to select and the track will begin to play.

Play a Whole Album

You may only play Whole Albums after you have accessed a computer's stored audio. Refer to the section titled "Accessing a Computer's Stored Audio" on page 22.

1. Turn the dial to "**Music**" — press the dial to select.
2. Turn the dial to "**Album Artist**" — press the dial to select.
3. Turn the dial to the desired artist — press the dial to select.
4. Turn the dial to the desired album — press the dial to select.
5. Turn the dial to [Add to Queue] — press the dial to select.

Queuing Up Tracks for Later Playback

Use the same process as playing a track (see above). The track selected will be added to the queue to play next.

Queuing Up Albums for Later Playback

Use the same process as playing a whole album (above). The album selected will be added to the queue to play next.

Media Player Controls

Play, Pause, and Stop: Use the ►||/■ button to play a track, pause a track, or hold button to stop a track.

Skip to Previous Track: Use the ◀◀ button to play the previous track in the queue.

Skip to Next Track: Use the ▶▶| button to play the next track in the queue.

Display Play Mode (remote control only): Use the "MODE" button to show repeat and shuffle mode status.

Media Player Functions

Browsing the List of Queued Tracks

Press the BROWSE button on the remote control. The name of the track that is currently playing will be listed first. Turn the dial clockwise or press the ▼ button on the remote control, to view all the tracks listed in the queue.

If you want to jump ahead to a particular place in the queue, scroll to the desired track and press the dial to select.

Playing Queued tracks in random order (Shuffle Play)

Note: The remote control can also be used.

1. Briefly press the dial once to access the Primary Menu. You can also access the Primary Menu by pressing and holding the BACK button.

The Primary Menu contains contains six options: **STATIONS, PERSONAL RADIO, MY STUFF, MEDIA PLAYER, CONFIGURE** and **ALARM CLOCK**.

2. Turn the main dial clockwise until “**Media Player**” shows in brackets — press the dial to select.
3. Turn the dial clockwise until “**Playback Mode**” shows — press the dial to select.
4. Turn the dial clockwise until “**Shuffle**” shows — press the dial to select.

Repeat Queued Tracks After All Have Played

1. Briefly press the dial once to access the Primary Menu. You can also access the Primary Menu by pressing and holding the BACK button.

The Primary Menu contains contains six options: **STATIONS, PERSONAL RADIO, MY STUFF, MEDIA PLAYER, CONFIGURE** and **ALARM CLOCK**.

2. Turn the main dial clockwise until “**Media Player**” shows in brackets — press the dial to select.
3. Turn the dial clockwise until “**Playback Mode**” shows — press the dial to select.
4. Turn the dial clockwise until “**Repeat**” shows — press the dial to select.

Configure Menu Options

To access the “Configure” menu follow these steps:

1. Briefly press the dial once to access the Primary Menu. You can also access the Primary Menu by pressing and holding the BACK button.

The Primary Menu contains six options: **STATIONS, PERSONAL RADIO, MY STUFF, MEDIA PLAYER, CONFIGURE** and **ALARM CLOCK**.

2. Turn the main dial until “**Configure**” shows in brackets — press the dial to select. Turn the dial clockwise to access all the options.

<Wi-Fi and Network Setup>

This option is used for configuring your radio’s network settings, network parameters, and scanning for wireless networks. Once the radio has established a connection to the network, the information will be saved to the radio for later use.

<Version>

Displays the electronic serial number and other information pertaining to software and hardware installed on your internet radio.

<Network Firmware Upgrade>

Use this option to download new control programming for the radio. If there is new firmware available when this option is selected, then the radio will prompt you to download.

Note: A firmware upgrade may take several minutes. **DO NOT TURN OFF THE POWER TO YOUR RADIO WHEN UPGRADING FIRMWARE.**

Configure Menu Options

If the firmware upgrade is interrupted, your radio may endure permanent damage. A firmware upgrade may take several minutes to finish.

<Language>

Allows you to change the display language.

<Reset Factory Defaults>

This option puts all settings back to their default, as they were when the radio left the factory. If you perform a factory reset on your radio, you will lose all your presets, clock settings, and wireless network connection settings.

<Get Registration Key>

This option will display a key that can be used to register the radio on the Reciva Customer Portal.

<Clock Set Up>

Use this option to set the time, date and clock format. See “Setting the Time and Date” on page 18.

<Backlight Settings>

Selecting this option will alter the Internet radio’s backlight values.

1. After selecting the “Backlight” menu item, the radio will show three backlight adjustment modes: **“Inactive”**, **“Active”**, and **“Standby”**. These three settings are explained below:
 - a) The “active” state is when the user is pressing buttons or turning knobs.
 - b) The radio goes into its “inactive” state when there is no user activity for 30 seconds.
 - c) “Standby” is the state when the radio has been turned off.
2. Rotate the dial to select the desired backlight mode — press the dial to select.
3. The radio will display the current backlight value for the selected mode. You can change this value by turning the dial to increase or decrease it.

<UPNP>

Use this option to set a name for your radio that can be recognized by

Configure Menu Options

the UPNP Server.

<WiFi Signal Strength>

This option will give you your current WiFi signal strength between the radio and the router. Our experience shows that a signal strength of 20 to 30% is required for good reception.

Configuring “My Stuff”

Registering an account on Reciva’s website:

1. Open Reciva’s website, <http://radios.reciva.com>, from your Internet browser on your computer.
2. Enter your Register Code, which can be found from the “Configure > Get Registration Key” menu on the radio. Refer to page 42 for the Menu Flowchart.
3. Follow the onscreen instructions to “Create Account” or log in if you already have an account. Your radio has now been added to your Reciva account.
4. Once you are logged into your account, click on “Manage My Stuff”. You will be able to add or edit information for “My Stations”, “My Streams”, and “My Podcasts”.

A button with the text "Manage My Stuff" and a right-pointing arrow icon.

Configuring “My Stations”

You can search for radio stations that are available in Reciva’s database on their website or from your radio (see page 13).

1. Click in the box titled “Search for Stations”.

A search input field with the placeholder text "search for stations" and a magnifying glass icon. The text "kgo" is entered in the field. To the right is a "Search" button. Below the field is a link for "Advanced Search".

search for stations Search

[Advanced Search](#)

2. Type the call letters of the station to search.
3. Click the Search button.
4. Reciva will display a list of search results.

Configuring “My Stations”

5. Click on the Station Icon of your choice.
6. Reciva will show that the station has “Passed or Failed the Reciva Daily Stream Test”.
7. If the radio station “Passed”, scroll down and click the “Add to My Stations” button. 
8. Your station will be added to your account’s “My Stations” list. This list can be viewed or edited by clicking on the “Go to My Stations” link.
9. Once your selected Internet station appears in your “My Stations” list, you may play these stations from your CC WiFi radio.
10. These stations will be available on your radio from the Primary Menu as “My Stuff”.

Tip: To add or remove a station from “My Stations” with the radio: Press the “Reply Button” while listening to the station, then select “Add to My Stations” or “Delete from My Stations”.

Adding Content to “My Streams” or “My Podcasts”

1. Once you are logged into your Reciva website account, you can add custom content to the “My Streams” or “My Podcasts” sections.
2. Click on “**Manage My Stations**”, then click on either “**My Streams**” or “**My Podcasts**”.
3. Follow the onscreen instructions to enter the name of the stream or podcast and its media stream URL. Click on Save. The media stream URL should be a link to a website’s actual audio stream. If you have any doubt about locating the media stream URL from a web page, please refer to the Forum section on Reciva’s website for instructions.
4. After the stream or podcast as been added, you may play them from your Internet radio. The new programming will be available on your radio from the Primary Menu in “My Stuff”.

Note: Newly added streams or podcasts will only be available to your radio once your radio has downloaded a new “stations” list. To cause the radio to download a new stations list immediately, remove and reconnect the power to your radio.

Setting Up Extra Features

There are several extra features and services that can be added to your CC WiFi Radio to enhance your listening experience. These services cannot be added to your radio until you have created a Reciva radio account online. See “Configuring “My Stuff” on page 28. Once your computer is logged-in to your Reciva radio account (*radios.reciva.com*), follow the steps below:

1. Click on “See extra features”. 
2. From the dropdown window, click on the logo of the extra feature that you want to add to your radio.
3. Follow the onscreen instructions that explain how to sign up for the extra feature that you want to add to your radio.
4. After setup is complete, come back to your CC WiFi Radio. Unplug the power cable momentarily and reinsert it again.

Using “My Pandora”

Before setting up Pandora on your radio, you must first add this extra feature to your Reciva radio account. See “Setting Up Extra Features” above.

Using Pandora:

1. Select “**Personal Radio**” and then select “**My Pandora**”.



2. If you have previously used Pandora with your computer online then you can listen to one of your stations by selecting “**Stations**”.



3. Once “Stations” is selected, you can browse through your previously added stations by rotating the dial. When you are ready to play the station, position the brackets on either side of the selection and press the dial to select.

Using “My Pandora”

< The Beatles Radio >
The Doors Radio

4. If you are new to Pandora, you will not have any stations yet. Select **“Create Station”** and then enter in your favorite song title or artist name. Notice that the middle character on the top line is the one that is ready for selection. Rotate the dial to the desired character and then press SELECT by pressing the dial in. When a character is selected, it will be displayed on the lower line.

Stations
< Create Station >

< **END** < > A BCDE >
ELVIS PRESLEY

5. When finished, rotate the dial until **“END”** is located in the middle of the upper line and then press SELECT. You can now rotate the dial and select one of the search results.

< }()~ **END** < > AB >
ELVIS PRESLEY

ELVIS PRESLEY (ARTIST)
Elvis Presley & Lisa

6. Once a result is selected, Pandora will begin to play music that is similar to the artist or song title that was selected and create a “station” of that music. It will be listed as “Elvis Presley Radio”, as in our example. By pressing the “REPLY” button on the CC WiFi Radio, you will be shown a menu in which you will have further control options, such as “SKIP” song or “Give Feedback”, where you can give the currently playing song a “Thumbs Up” or “Thumbs Down”. If you choose “Thumbs Up” then this song will be played more. If “Thumbs Down” is selected, the song will never be played again on this station. Note: “Add Feedback” does not work on all stations. The “SKIP” song option is limited to only 6 skips per station, per hour.

Elvis Presley Radio
I Walk the Line by John

< Give Feedback >
SKIP

Note: It is possible to assign this station to an available preset on

Using “My Pandora”

your radio for quick playback. Also, this station will be saved in the “Stations” portion of “My Pandora”. Visit www.pandora.com for more options using the same Pandora username and password that you entered into your Reciva account.

“No Networks Found” shows after scanning for wireless networks:

1. Sometimes your wireless network will not show on the first scan. Try scanning for networks again on your radio.
2. Check the LED lights on the front of your wireless router. Be sure that the “power” and “wireless” LED lights are on. If they are not on, you may need to call the manufacturer of the router for more assistance.
3. Your radio may be out of range of your wireless network. Place the radio closer to your router as a test, then scan for wireless networks again. The CC WiFi Radio may not have the same WiFi range as a new WiFi enabled laptop.
4. There is a setting on your WiFi router called “Enable SSID Broadcast”. This must be enabled. You may need to call the manufacturer of the router for more assistance.

About Your Network Name (SSID): This is the name which was assigned to your wireless router by the person who set it up. After scanning for your wireless network, rotate the dial through all of the results because you may recognize your network name (SSID). If your router’s manufacturer name is displayed, try selecting it (e.g., “Linksys” or “Netgear”). If your wireless network has not been renamed from the default factory name, then it most likely does not require a wireless encryption key (WEP or WPA) password to connect.

About Your WEP or WPA Encryption Key: This is also called a “Wireless Network Password” and is used to keep unwanted “guests” from using your wireless network. If you are unaware of what your password is, you can follow our suggested steps for finding it:

1. Search your records for a document that was printed out after the setup of your router. This document should contain the WEP Key or WPA Passphrase. If your router was setup by someone else, they should have provided you with a document that contained the needed information.
2. If you are using a wireless router that was provided by your Internet Service Provider, the WEP or WPA key will sometimes be

printed on the bottom of the router.

3. If all else fails, try calling the manufacturer of your wireless router for assistance with locating the routers wireless encryption key.

Having Trouble Connecting to a Wireless Network: This problem can be caused by a number of possible scenarios.

1. Check your WEP or WPA wireless encryption key — it may be wrong. If you don't know your WEP or WPA encryption key, refer to the section above titled “About Your WEP or WPA Encryption Key.
2. WEP keys should be entered using uppercase letters A-F and numbers 0-9. WEP keys are easy to spot because they use either 10 total characters or 26 total characters. When entering a WPA key you must enter it exactly as entered in your router's settings, including upper and lower case letters.
3. After scanning for wireless networks, turn the dial through all the possible choices. You may recognize your network as another name.
4. Be sure that your internet is working. Try accessing the internet using a computer that is connected to the same router as the radio. If you cannot access the internet on your computer, the radio will not connect either. It may be necessary to call your internet service provider for help repairing your internet connection.
5. If still no success, then call C. Crane (800-522-8863) for troubleshooting assistance.

Timeout Getting IP Address:

1. An incorrect WEP or WPA key may have been entered into the radio. This is the most common reason for this error. Check your router to make sure your wireless encryption key is correct or see page 33-34 for more help with finding your encryption key. A good troubleshooting test is to temporarily try connecting to your router with encryption disabled.
2. Your radio may be too far away from the wireless router. Try moving it closer.
3. Wireless router is not DHCP enabled. Consult your router's user manual for enabling DHCP or contact the manufacturer of the router for more assistance.
4. Your router may be using an unknown encryption type. Try a different type of encryption on your router. One good troubleshooting test is to temporarily disable your router's encryption and see if the radio connects to it.
5. There may be too much interference from nearby wireless devices. Move the radio away from laptops or other wireless devices. 2.4GHz telephones and baby monitors can cause interference, if placed near the radio.
6. You may be attempting to connect to an ad-hoc type network. If you are attempting to connect to a network that is not yours, it may be configured for ad-hoc (computer-to-computer) and may not have internet. To check what network type you are connecting to, use your computer to scan for available networks. On the list of available networks you should be able to see if the network is infrastructure type (good) or ad-hoc (bad).

Port 80 Connect Failed. Unable to Load Station List:

Your radio is unable to connect to Reciva using the internet.

1. Your internet connection may not be working. Check the internet using a computer that is connected to the same router.

2. UPNP may be disabled on your router. UPNP must be enabled for the radio to work correctly. Consult your router's user manual for enabling UPNP or contact the manufacturer of the router for more assistance.
3. Your router or modem may be temporarily confused even though your computer is working fine. Try unplugging the power from both the router and modem for two minutes. First, power the modem (giving it time to startup), then power the router (also giving it time to startup). Last, power your radio and try connecting again.

Timeout Connecting to Reciva Gateway.

Check Firewall Port 5000:

Your router is not letting the radio connect to Reciva using the UPNP service.

1. UPNP may be disabled on your router. UPNP must be enabled for the radio to work correctly. Consult your router's user manual for enabling UPNP or contact the manufacturer of the router for more assistance.
2. Your router or modem may be temporarily confused even though your computer is working fine. Try unplugging the power from both the router and modem for two minutes. First, power the modem (giving it time to startup), then power the router (also giving it time to startup). Last, power your radio and try connecting again.
3. Your internet provider may be blocking UPNP (port 5000) from being used by their customers. This is very uncommon but some satellite internet companies, colleges, and businesses block this port for an extra layer of network security. To find out if this port is being blocked, speak with your internet service provider or system administrator.
4. Your router may not offer the UPNP setting. In this case, manually open port 4999-5001 and assign these open ports to an IP address that is a little higher than your computer's. (Example: If your computer's IP address is 192.168.1.5, assign the open ports to 192.168.1.9.) On your radio, select **"Configure"**, then select **"Wi-Fi and Network Setup"**, then select **"Edit Configuration"**. When the message displays **"Auto DHCP Yes or No"** select **"NO"**. From this point, enter the new IP address that has the open ports assigned to it, along with other network information.

Having Trouble Playing a Radio Station?

1. If you are unable to play all radio stations, the radio may have lost connection to your router or internet connection. Unplug the radio's power cord momentarily and reconnect.
2. The radio is "buffering" on a particular station:
 - Try moving the radio closer to the router.
 - If this does not help, the station may be overloaded with connected listeners.
 - The station may have changed their streaming information. If using a preset to play the station, you may want to try searching for the station using the Search feature. If the station plays then you can re-assign the station to your preset.
 - If above does not help, please contact C. Crane.

Having Trouble Finding a Particular Radio Station?

If you are unable to find a radio station by using the regular radio search options, iHeartRadio and CBS stations are listed under a separate category of their own (see pages 14 through 16). You can also visit <https://radios.reciva.com/station> to try to search for a station.

How Do I Add a New Station to Reciva?

To add a station to Reciva, you will need to know the actual web address for the station's stream and you will need to be logged into your Reciva account at <https://radios.reciva.com/addstation/>. If you are having troubles finding or adding a station, please contact C. Crane at (800) 522-8863.

Menu Flow Chart

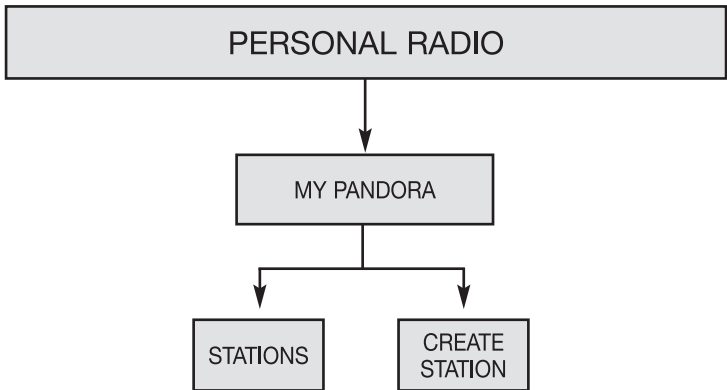
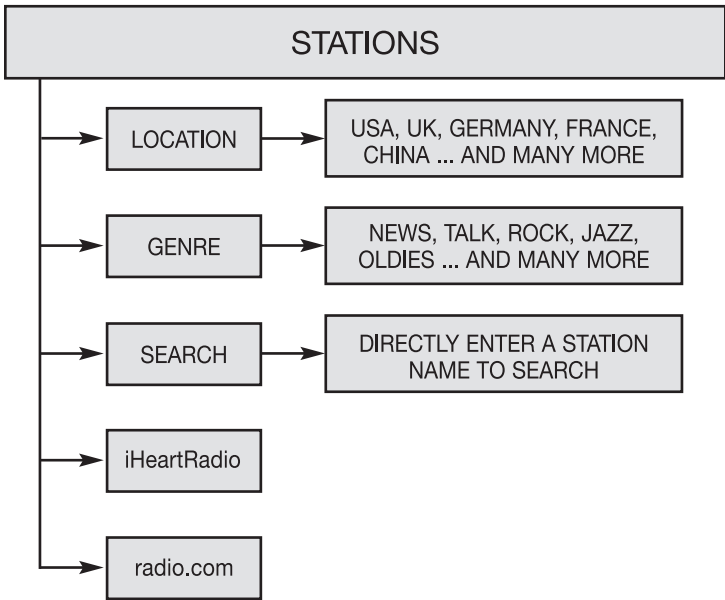

Menu Flow Chart

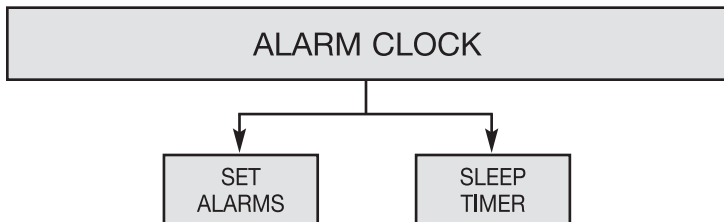
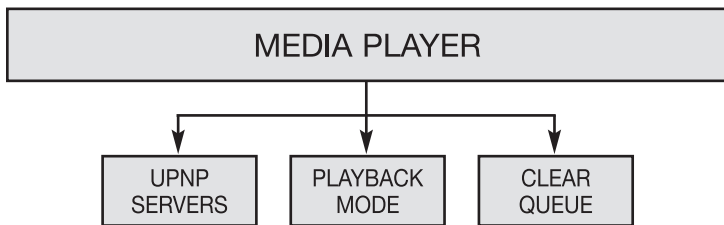
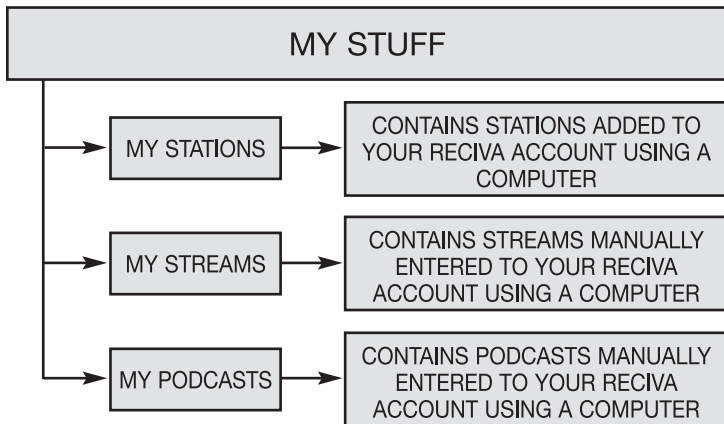

Menu Flow Chart - Wifi and Network Setup

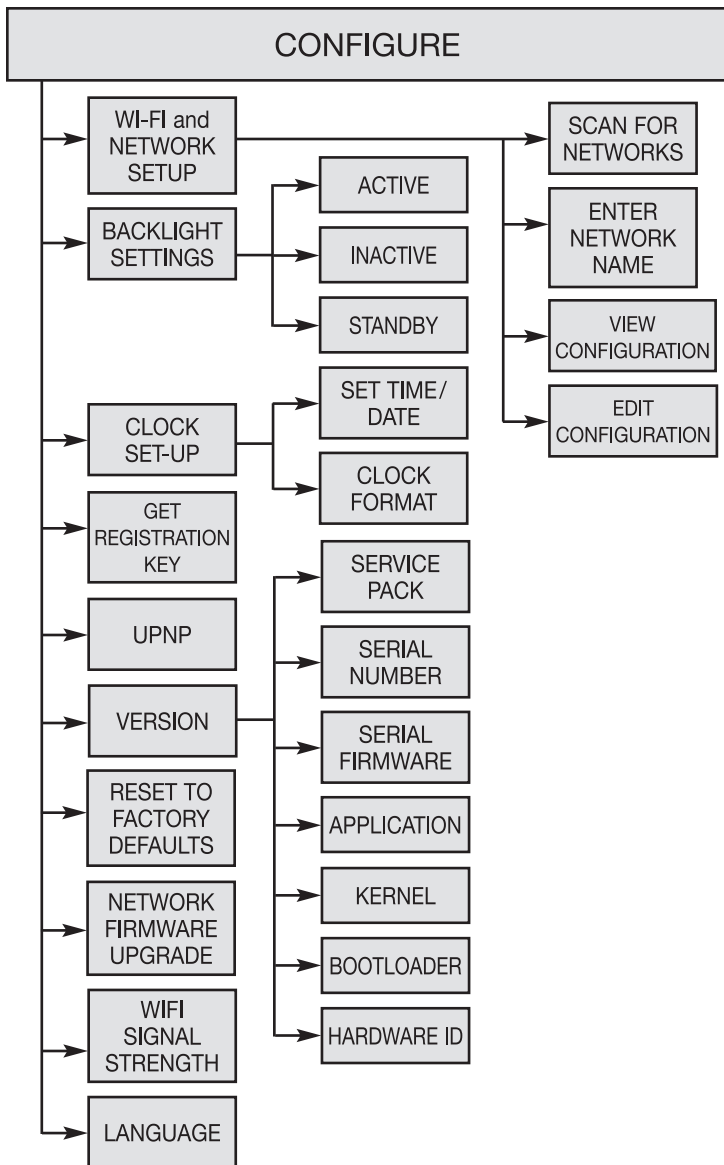

Safety Instructions



**READ BEFORE
OPERATING EQUIPMENT
SAVE THESE INSTRUCTIONS**



To prevent damage to your radio or possible injury to you or others, read these safety precautions and instructions entirely before applying power to your radio. Keep these precautions and instructions where all who use this radio will read them.

1) COMMON CARE ⚠

Check the radio, AC adapter and any accessories regularly. Do not use the radio if there is any sign of damage. Only operate in accordance with the instructions in this manual. Only use attachments or accessories specified by the manufacturer.

2) DISCONNECT THE RADIO IN CASE OF MALFUNCTION ⚠

If you smell or notice smoke, disconnect the AC Adapter immediately, taking care to avoid burns. Contact C. Crane Company or their representative for inspection and service before any future operation. Only use the AC-DC Adapter recommended with the unit and replace it if wires become frayed or exposed. It should have an output of 7.5 Volts DC with the center positive, and not less than 1.2 Amps. Use only the recommended adapter. Otherwise it may damage the radio or cause a fire or electric shock.

3) KEEP OUT OF REACH OF CHILDREN ⚠

Dropping the radio can cause damage or injury. Keep the AC Adapter cord in a position so someone cannot trip and cause the radio to fall.

4) KEEP AWAY FROM WATER AND MOISTURE ⚠

Keep the radio dry. Liquids and moisture can damage the radio. If a liquid leaks into the radio do not operate and seek a qualified service shop. To clean the radio, remove the power and use a damp cloth on the exterior only.

5) KEEP AWAY FROM EXTREME TEMPERATURES ⚠

Extreme temperatures can damage the radio. Do not leave or use the radio where it can be subjected to high or very cold temperatures.

6) DO NOT ATTEMPT TO SERVICE RADIO ⚠

Refer all service work to a qualified service shop when the radio does not appear to operate normally, exhibits a change in performance or the radio has received damage. Never open the radio as this may expose you to dangerous voltages and this will void all warranties.

7) OUTSIDE ANTENNAS OR CABLES ⚠

Outside antennas or cables that create a potential hazard should not be used with this radio unless installed by qualified personnel.

Memory Preset Log

Preset	Location/Genre	Station	Host
1			
2			
3			
4			
5			
6			
7			
8			
9			
10			
11			
12			
13			
14			
15			
16			
17			
18			
19			
20			
21			
22			
23			
24			
25			

Please feel free to copy this page.

Memory Preset Log

Preset	Location/Genre	Station	Host
26			
27			
28			
29			
30			
31			
32			
33			
34			
35			
36			
37			
38			
39			
40			
41			
42			
43			
44			
45			
46			
47			
48			
49			
50			

Please feel free to copy this page.

Memory Preset Log

Preset	Location/Genre	Station	Host
51			
52			
53			
54			
55			
56			
57			
58			
59			
60			
61			
62			
63			
64			
65			
66			
67			
68			
69			
70			
71			
72			
73			
74			
75			

Please feel free to copy this page.

Memory Preset Log

Preset	Location/Genre	Station	Host
76			
77			
78			
79			
80			
81			
82			
83			
84			
85			
86			
87			
88			
89			
90			
91			
92			
93			
94			
95			
96			
97			
98			
99			
100			

Please feel free to copy this page.

Location of Your CC WiFi Radio Serial Number

From the “Primary Menu” of the CC WiFi Radio, follow this path to find your serial number: **Configure > Version > Serial Number**

Record your serial number here for future reference:

This product contains software licensed under version 2 of the GNU public license and version 2.1 of the GNU Lesser Public License.

This product includes technology owned by Microsoft Corporation and under a license from Microsoft Licensing GP. Use or distribution of such technology outside of this product is prohibited without a license from Microsoft Corporation and/or Microsoft Licensing, GP as applicable.

Model: CC Wifi
ANSI C63.4: 2003

THIS DEVICE COMPLIES WITH PART 15 OF THE FCC RULES. OPERATION IS SUBJECT TO THE FOLLOWING TWO CONDITIONS.

- 1) THIS DEVICE MAY NOT CAUSE HARMFUL INTERFERENCE, AND
- 2) THIS DEVICE MUST ACCEPT ANY INTERFERENCE RECEIVED, INCLUDING INTERFERENCE THAT MAY CAUSE UNDESIRE OPERATION.

Notice: Any changes or modifications not expressly approved by the party responsible for compliance could void the user's authority to operate the equipment.